

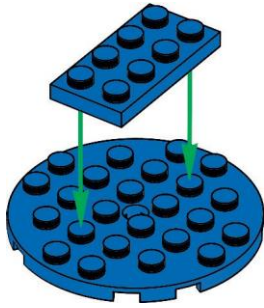

# DOG (EN) CHIEN (FR)



1



2

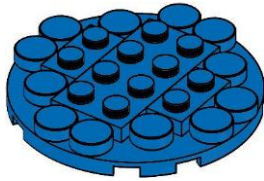

3

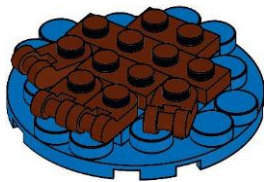

4

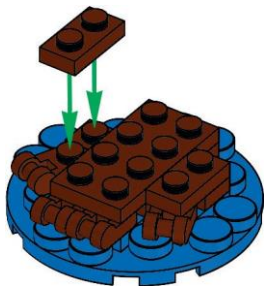

5

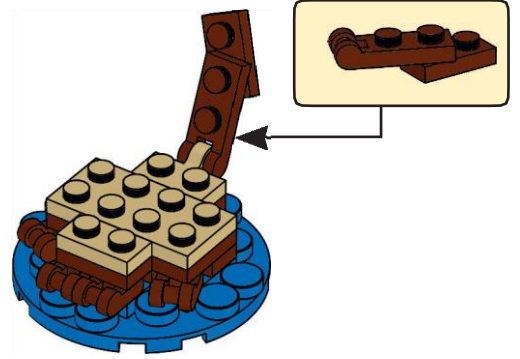

6

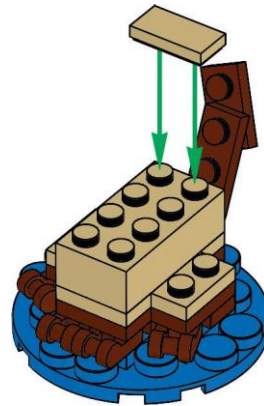

7

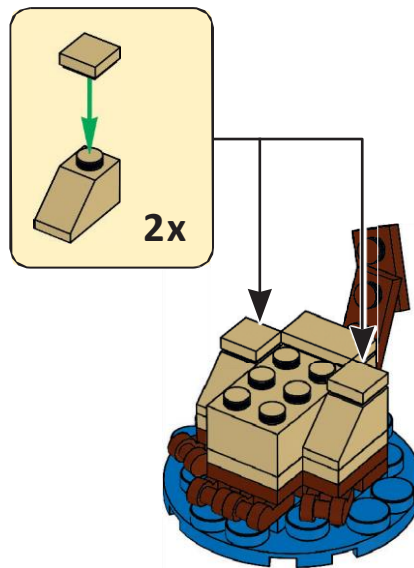

8

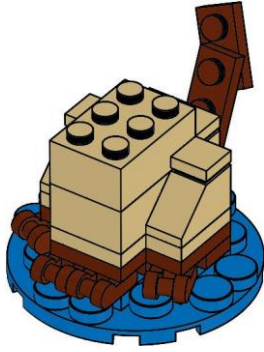

9

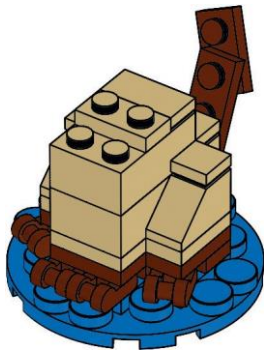

10

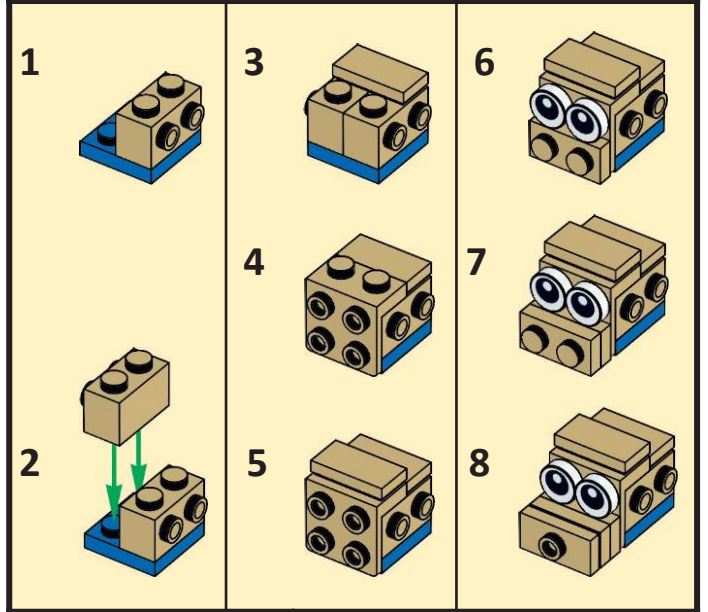
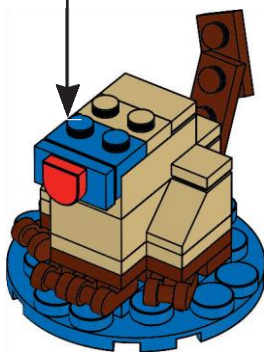
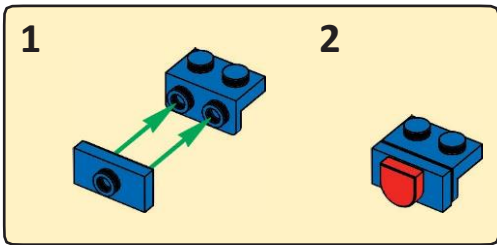

11

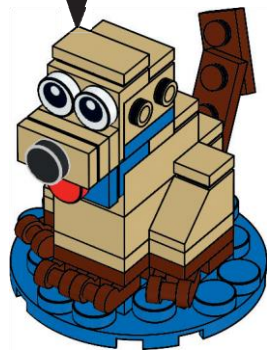

12

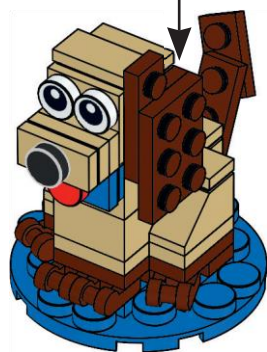
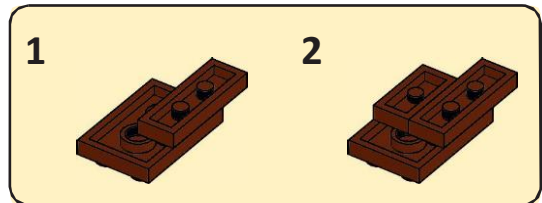

13

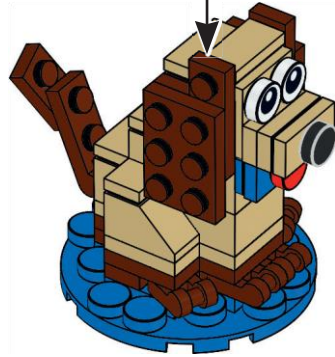
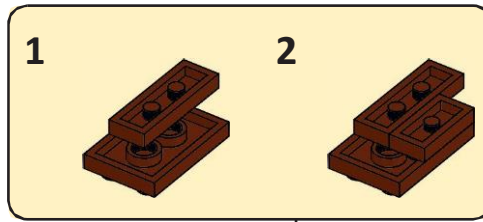

 2x 302323	 1x 6117975	 2x 4125253	 1x 6096711
 1x 6163471	 1x 4159739	 1x 6177314	 1x 4211190
 1x 302223	 1x 4114309	 4x 4114026	 1x 4211186
 1x 302023	 1x 4114319	 1x 6092587	 1x 6102975
 1x 6284070	 1x 6258973	 2x 6024495	 2x 4211152
 4x 6153863	 12x 6284575	 4x 4113917	 2x 4211189
 7x 4211150	 1x 6092582	 2x 4121972	 2x 6284599